



PII: S0040-9383(97)00028-1

ON FINITE TYPE 3-MANIFOLD INVARIANTS III: MANIFOLD WEIGHT SYSTEMS

STAVROS GAROUFALIDIS and TOMOTADA OHTSUKI

(Received for publication 9 June 1997)

The present paper is a continuation of [11, 6] devoted to the study of finite type invariants of integral homology 3-spheres. We introduce the notion of *manifold weight systems*, and show that type m invariants of integral homology 3-spheres are determined (modulo invariants of type $m - 1$) by their associated manifold weight systems. In particular, we deduce a vanishing theorem for finite type invariants. We show that the space of manifold weight systems forms a commutative, co-commutative Hopf algebra and that the map from finite type invariants to manifold weight systems is an algebra map. We conclude with better bounds for the graded space of finite type invariants of integral homology 3-spheres. © 1997 Elsevier Science Ltd. All rights reserved

1. INTRODUCTION

1.1. History

The present paper is a continuation of [11, 6] devoted to the study of finite type invariants of oriented integral homology 3-spheres.

There are two main sources of motivation for the present work: (perturbative) Chern–Simons theory in three dimensions, and Vassiliev invariants of knots in S^3 .

Witten [16] in his seminal paper, using path integrals (an infinite dimensional “integration” method) introduced a topological quantum field theory in three dimensions whose Lagrangian was the Chern–Simons function on the space of all connections. The theory depends on the choice of a semi-simple Lie group G and an integer k . The expectation values (in \mathbb{C}) of the above mentioned quantum field theory yield invariants of 3-manifolds (depending on G and k) and invariants of knots in 3-manifolds (depending on G, k , and the choice of a representation of G).

Though the above mentioned path integrals have not yet been defined, and an analytic definition of the theory is not yet possible, shortly afterwards many authors proposed (rigorous) combinatorial definitions for the above mentioned invariants of knots and 3-manifolds. It turned out that the knot invariants (for knots in S^3) are values at roots of unity for the various Jones-like polynomials, what we call quantum invariants, of knots.

The results mentioned so far are non-perturbative, i.e., involve a path integral over the space of all connections.

Perturbatively, i.e., in the limit $k \rightarrow \infty$ one expects invariants of knots/3-manifolds that depend on the choice of a G flat connection. The G flat connections are the critical points of the Chern–Simons function, and form a finite dimensional (however singular) topological space. Due to the presence of a cubic term in the Chern–Simons function, one expects contributions to the perturbative invariants coming from trivalent graphs (otherwise called Feynman diagrams; we will denote the set of Feynman diagrams by $\mathcal{B}\mathcal{M}$ below). Such invariants have been defined by [1, 2].

Further we can expect that there should exist a universal quantum invariant of 3-manifolds with values in the space of Feynman diagrams.

The second source of motivation comes from the theory of finite type knot invariants. Finite type knot invariants (or Vassiliev invariants) were originally introduced by Vassiliev [15]. For an excellent exposition including complete proofs of the main theorems see [3] and references therein. We will proceed in analogy with features in Vassiliev invariants.

Finite type knot invariants have the following (rather appealing) features:

- There is an *axiomatic* definition (over \mathbb{Z}) (see [3]) that resembles a “difference formula” of multivariable calculus. They form a filtered commutative co-commutative algebra $\mathcal{F}_* \mathcal{V}$.
- There is a map $\mathcal{F}_m \mathcal{V} \rightarrow \mathcal{G}_m \mathcal{W}$ to the space of *weight systems* $\mathcal{G}_m \mathcal{W}$. $\mathcal{G}_m \mathcal{W}$ is a *combinatorially* defined, finite dimensional vector space naturally isomorphic to a few other vector spaces based on trivalent graphs (see [3]).
- The above mentioned map is not one-to-one, however one has the following short exact sequence:

$$0 \rightarrow \mathcal{F}_{m-1} \mathcal{V} \rightarrow \mathcal{F}_m \mathcal{V} \rightarrow \mathcal{G}_m \mathcal{W} \rightarrow 0 \tag{1}$$

This is a general existence theorem for Vassiliev invariants due to Kontsevich [7], which gives rise to the *universal* Vassiliev invariant (with values in a space of chord diagrams).

- Examples of Vassiliev invariants are the derivatives (at 1) of quantum invariants of knots in S^3 .
- There are two contradictory conjectures: one that asserts that Vassiliev invariants separate knots in S^3 , and the other that asserts that all Vassiliev invariants come from “semi-simple Lie algebras”. There is favor for each of them.

We observe similar features in the case of our finite type invariants of 3-manifolds. For the first feature, we define a commutative co-commutative algebra structure in our space \mathcal{BM} . For the third feature, we have a short exact sequence in Theorem 2 below, though it might still be incomplete comparing to the above exact sequence. For the fourth feature, we expect that λ_n defined in [11] should be finite type, see Question 2 below.

1.2. Statement of the results

We begin by introducing some notation and terminology which will be followed in the rest of the paper. Let M be an oriented integral homology 3-sphere. A *framed link* $\mathcal{L} = (L, f)$ is an unoriented link $L = L_1 \cup L_2 \cup \dots \cup L_n$ in M with framing $f = (f_1, f_2, \dots, f_n)$ (since M is a integral homology 3-sphere, we can assume that $f_i \in \mathbb{Z}$). A framed link (L, f) is called *unit-framed* if $f_i = \pm 1$ for all i . A framed link (L, f) is called *algebraically split* if the linking numbers between any two components of L vanish, *boundary* if each component of L bounds a Seifert surface such that the Seifert surfaces are disjoint from each other.

Let \mathcal{M} be the vector space over \mathbb{Q} on the set of integral homology 3-spheres. The motivations from Chern–Simons theory and from finite type knot invariants described in Section 1.1. gave rise to the following definition due to the second named author of finite type invariants of integral homology 3-sphere:

Definition 1.1. A linear map $v: \mathcal{M} \rightarrow \mathbb{Q}$ is a type m invariant in the sense of [11] if it satisfies

$$\sum_{\mathcal{L}' \subseteq \mathcal{L}} (-1)^{\#\mathcal{L}'} v(M_{\mathcal{L}'}) = 0$$

for every integral homology 3-sphere M and every algebraically split unit-framed link \mathcal{L} of $m + 1$ components in M , where $\#\mathcal{L}'$ denotes the number of components of \mathcal{L}' , $M_{\mathcal{L}'}$ the integral homology 3-sphere obtained by Dehn surgery on M along \mathcal{L}' and the sum runs

over all sublinks of \mathcal{L} including empty link. Let $\mathcal{F}_m \mathcal{O}$ (resp. \mathcal{O}) denote the vector space of type m (resp. finite type) invariants in the sense of [11]

Remark 1.2. It will be useful in the study of finite type invariants to introduce the decreasing filtration \mathcal{F}_\star on \mathcal{M} . For a framed link \mathcal{L} in M we define (M, \mathcal{L}) by

$$(M, \mathcal{L}) = \sum_{\mathcal{L}' \subseteq \mathcal{L}} (-1)^{\#\mathcal{L}'} M_{\mathcal{L}'} \in \mathcal{M}. \tag{2}$$

We can now define a decreasing filtration \mathcal{F}_\star on the vector space \mathcal{M} as follows: $\mathcal{F}_n \mathcal{M}$ is the subspace of \mathcal{M} spanned by (M, \mathcal{L}) for all integral homology 3-sphere M and all algebraically split unit-framed framed links of n components. Let $\mathcal{G}_n \mathcal{M}$ denote the associated graded vector space. Note that $v \in \mathcal{F}_n \mathcal{O}$ if and only if $v(\mathcal{F}_{n+1} \mathcal{M}) = 0$. This implies that $\mathcal{M}/\mathcal{F}_{n+1} \mathcal{M}$ is the dual vector space of $\mathcal{F}_n \mathcal{O}$. Note also that if $\mathcal{L} \cup \mathcal{K}$ denotes an algebraically split unit-framed link (with a distinguished component of it, \mathcal{K}) in an integral homology 3-sphere M , then the following fundamental relation holds:

$$(M, \mathcal{L} \cup \mathcal{K}) = (M, \mathcal{L}) - (M_{\mathcal{K}}, \mathcal{L}) \tag{3}$$

where we also denote by \mathcal{L} in $M_{\mathcal{K}}$ the same framed link \mathcal{L} after doing Dehn surgery along \mathcal{K} . Note (trivially) that the left-hand side of (3) involves links with one component more than the right hand side, an observation that will be useful in the philosophical comment below.

Remark 1.3. A variation of Definition 1.4 of finite type invariants of integral homology 3-spheres was introduced by the first author [5]: a type m invariant in that sense is a map $v: \mathcal{M} \rightarrow \mathbb{Q}$ such that $v(\mathcal{F}_{m+1}^{\text{Ga}} \mathcal{M}) = 0$, where $\mathcal{F}_m^{\text{Ga}} \mathcal{M}$ is the subspace of \mathcal{M} spanned by all pairs (M, \mathcal{L}) for unit-framed boundary links L in integral homology 3-spheres M . We will not study this definition in the present paper though.

In analogy with the notion of Vassiliev invariants of knots, we introduce the following notions:

Definition 1.4.

- A *Chinese manifold character* (CMC) is a (possibly empty or disconnected) graph whose vertices are trivalent and oriented (i.e., one of the two possible cyclic orderings of the edges emanating from such a vertex is specified). Let $\mathcal{C}\mathcal{M}$ denote the set of all Chinese manifold characters. $\mathcal{C}\mathcal{M}$ is a graded set (the degree of a Chinese manifold character is the number of the edges of the graph).

- An *extended Chinese manifold character* (ECMC) is a (possibly empty or disconnected) graph whose vertices are either trivalent and oriented, or univalent. Let $\widetilde{\mathcal{C}\mathcal{M}}$ denote the set of all extended Chinese manifold characters. $\widetilde{\mathcal{C}\mathcal{M}}$ is a graded set with the same degree as the case of CMC.

- Let

$$\mathcal{B}\mathcal{M} = \text{span}(\mathcal{C}\mathcal{M}) / \{AS, IHX\} \tag{4}$$

$$\widetilde{\mathcal{B}\mathcal{M}} = \text{span}(\widetilde{\mathcal{C}\mathcal{M}}) / \{AS, IHX, IS\} \tag{5}$$

Here *AS* and *IHX* are the relations referred to in Figs 9 and 26, and *IS* is the set of extended Chinese manifold characters containing a component which is an interval, i.e., a graph with two vertices and a single edge. $\mathcal{B}\mathcal{M}$ and $\widetilde{\mathcal{B}\mathcal{M}}$ inherits a grading from $\widetilde{\mathcal{C}\mathcal{M}}$ and $\mathcal{C}\mathcal{M}$

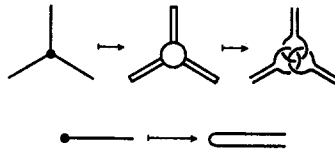

Fig. 1. From vertex-oriented graphs to links in S^3 .



Fig. 2. A marking of an edge and the part of the corresponding link.

respectively. We denote by ι a linear map of $\mathcal{B}\mathcal{M}$ to $\widetilde{\mathcal{B}\mathcal{M}}$ which is induced by the inclusion of $\mathcal{C}\mathcal{M}$ to $\widetilde{\mathcal{C}\mathcal{M}}$.

• A manifold weight system of degree m is a map $W : \mathcal{G}_m \mathcal{B}\mathcal{M} \rightarrow \mathbb{Q}$. The set of manifold weight systems of degree m is denoted by $\mathcal{G}_m \mathcal{W}\mathcal{M}$.

With the above notation, let us recall the following map introduced by the second named author in [11]:

$$\tilde{O}_m^* : \mathcal{G}_m \widetilde{\mathcal{C}\mathcal{M}} \rightarrow \mathcal{G}_m \mathcal{M} \tag{6}$$

is defined as follows: for a Chinese manifold character Γ with m edges, we consider the ribbon graph obtained by replacing every trivalent vertex with an oriented small disk, and every edge by an oriented band. If an edge has a trivalent vertex in its end, the corresponding band is attached to the corresponding disk preserving the orientation as in Figs 1 and 2. The result is an algebraically split link $L(\Gamma)$ in S^3 . We define $\tilde{O}_m^*(\Gamma)$ to be the image of $(L(\Gamma), (1, 1, \dots, 1)) \in \mathcal{F}_m \mathcal{M}$ under the projection map $\mathcal{F}_m \mathcal{M} \rightarrow \mathcal{G}_m \mathcal{M}$. Note that it is non-trivial to show that the map (6) is well defined.

With these preliminaries, we recall the following theorem due to the second author:

THEOREM 1 (Ohtsuki [11]). *The map (6) is well defined and onto.*

We can now state the main result of this paper:

THEOREM 2.[†]

• The composition of the map (6) with the deframing map F in (11) of Definition 2.4 descends to a well defined map

$$\tilde{O}_m^* \circ F : \mathcal{G}_m \widetilde{\mathcal{B}\mathcal{M}} \rightarrow \mathcal{G}_m \mathcal{M}. \tag{7}$$

We denote $\iota \circ \tilde{O}_m^* \circ F$ by O_m^* .

• We have a surjection:

$$O_m^* : \mathcal{G}_m \mathcal{B}\mathcal{M} \rightarrow \mathcal{G}_m \mathcal{M}. \tag{8}$$

• Dually, we get a map $O_m : \mathcal{F}_m \mathcal{O} \rightarrow \mathcal{G}_m \mathcal{W}\mathcal{M}$. This map is not one-to-one, however one has the following exact sequence:

$$0 \rightarrow \mathcal{F}_{m-1} \mathcal{O} \rightarrow \mathcal{F}_m \mathcal{O} \rightarrow \mathcal{G}_m \mathcal{W}\mathcal{M} \tag{9}$$

[†] The theorem has recently been improved by the work of T. T. Q. Le, see the Appendix.

i.e., 3-manifold invariants are determined in terms of their associated manifold weight systems.

LEMMA 1.5. $\mathcal{G}_m \widetilde{\mathcal{C}\mathcal{M}} / \{AS, IS\}$ (and therefore, $\mathcal{G}_m \widetilde{\mathcal{B}\mathcal{M}}$ too) is a zero dimensional vector space if m is not a multiple of 3. Furthermore, $\mathcal{G}_{3m} \widetilde{\mathcal{B}\mathcal{M}}$ is generated by Chinese manifold characters each connected component of which is either the Y component,[†] or a trivalent graph with no univalent vertices.

Using the above lemma, which will be proved in Section 2.3 and Theorem 2 we obtain the following corollary:

COROLLARY 1.6. If m is not a multiple of 3, then $\mathcal{G}_m \mathcal{O} = 0$. In any case, it follows that $\mathcal{G}_m \mathcal{O}$ is a finite dimensional vector space.

Remark 1.7. The above Corollary 1.6 was also observed by [6]. It follows by the AS relation (which itself follows by Theorem 4.1 of [11] (see also [6])). In other words, the proof of Lemma 1.5 and Corollary 1.6 and does not need the extra IHX relation of Theorem 2.

There is more structure on the vector spaces \mathcal{O} and $\mathcal{B}\mathcal{M}$ which we now describe. Using the pointwise multiplication of 3-manifold invariants, we observed in [5] that there is a map $\mathcal{F}_m \mathcal{O} \otimes \mathcal{F}_n \mathcal{O} \rightarrow \mathcal{F}_{m+n} \mathcal{O}$, giving \mathcal{O} the structure of a (filtered) commutative algebra.

PROPOSITION 1.8.

- $\mathcal{B}\mathcal{M}$ (and therefore, $\mathcal{W}\mathcal{M}$ as well) has a naturally defined multiplication \cdot and comultiplication Δ , which together make it a commutative, co-commutative Hopf algebra. By the structure theorem of Hopf algebras, (see [14]) it follows that $\mathcal{B}\mathcal{M}$ is the symmetric algebra on the (graded) set of the primitive elements

$$\mathcal{P}(\mathcal{B}\mathcal{M}) = \{a \in \mathcal{B}\mathcal{M} : \Delta(a) = a \otimes 1 + 1 \otimes a\} \tag{10}$$

in $\mathcal{B}\mathcal{M}$.

- The set of primitive elements $\mathcal{P}(\mathcal{B}\mathcal{M})$ is the set of connected Chinese manifold characters.
- Furthermore, the map $O_m : \mathcal{F}_m \mathcal{O} \rightarrow \mathcal{G}_m \mathcal{W}\mathcal{M}$ is an algebra map.

COROLLARY 1.9.[‡] We have the following evaluation of dimensions of the graded vector spaces in low degrees.

| n | 0 | 3 | 6 | 9 | 12 |
|--|---|---|-----------------------|-----------------------|-----------------------|
| $\dim \mathcal{G}_n \mathcal{O}$ | 1 | 1 | $1 \leq \cdot \leq 2$ | $1 \leq \cdot \leq 3$ | $1 \leq \cdot \leq 5$ |
| $\dim \mathcal{G}_n \mathcal{B}\mathcal{M}$ | 1 | 1 | 2 | 3 | 5 |
| $\dim \mathcal{G}_n \mathcal{P}(\mathcal{B}\mathcal{M})$ | 1 | 1 | 1 | 1 | 2 |

Proof. The third and fourth lines in the table follow by a direct calculation. A computer version of the above calculation appears in [4]. The lower bounds on the second line follow

[†] A Y component is a graph with 1 vertex and 3 edges, as in the letter Y .

[‡] The corollary has recently been improved by the work of T. T. Q. Le, see the Appendix.

from the fact that $\mathcal{G}_3\mathcal{O}$ is a one dimensional vector space (spanned by the Casson invariant, as shown in [11]) and the fact that $\mathcal{G}_\star\mathcal{O}$ is a commutative algebra. The upper bounds follow from the third line and Theorem 2. \square

The first author conjectured in [5] that $\mathcal{F}_n^{\text{Ga}}\mathcal{M} = \mathcal{F}_{3n}\mathcal{M}$; this implies a claim that $\mathcal{G}_n\mathcal{M} = 0$ for n not a multiple of 3, which was further discussed by Rozansky in [12]. Corollary 1.6 gives the positive answer to the claim.

1.3. Plan of the proof

The present paper consists of two parts, Sections 2 and 3. Section 2 concentrates on three-dimensional topology. Using a restricted set of Kirby moves for surgery presentations of integral homology 3-spheres, we show Theorem 2. For the convenience of the reader, we divide the proof in Sections 2.4 and 2.5. We refer the reader to Section 1.4 for a philosophical comment on the proof of Theorem 2. In Section 2.3 we prove Lemma 1.5, and thus deduce Corollary 1.6.

Section 3 concentrates on the combinatorial aspects of trivalent graphs. We show Proposition 1.8 and deduce Corollary 1.9.

Finally, in Section 1.5 we pose some questions related to finite type invariants of integral homology 3-spheres.

1.4. A philosophical comment on the proof of Theorem 2

In case the proof of Theorem 2 is not too clear, the reader may find useful the following philosophical comment. In order to state it, let us introduce the following terminology: we call a *blow up* (of an element in $\mathcal{F}_\star\mathcal{M}$), the move of replacing the right-hand side of the fundamental relation (3) by the left-hand side in an expression of the above mentioned element. Similarly, we call a *blow down* the opposite move. Note that a blow up (respectively, a blow down) increases (respectively, decreases) the number of components of the link by one. With this terminology we can restate Remark 3.3 of [6] as follows: surgical equivalence is the relation generated by a sequence $B_1^+ B_1^- B_2^+ B_2^- B_3^+ B_3^- \dots$ (where B_i^+ are blow ups, B_i^- are blow downs). A mnemonic way for convincing oneself about that, is keeping track of the number of components of the links in the various proofs involved. Similarly, the relation in Theorem 4.1 of [11] (for a precise statement, see Theorem 5 of [6]) and the *AS* relation of the present paper is proven using a sequence $B_1^- B_1^+ B_2^- B_2^+ B_3^- B_3^+ \dots$. The *IHX* relation in the present paper is proven using a sequence $B_1^- B_2^- B_1^+ B_1^+ \dots$. Of course, blow ups do not commute with blow downs, and as a result of this non-commutativity we obtain the *IHX* relation.

1.5. Questions

Question 1.[†] Is it true that the map $O_m: \mathcal{F}_m\mathcal{O} \rightarrow \mathcal{G}_m\mathcal{W}\mathcal{M}$ is onto, i.e., does every manifold weight system integrate to a integral homology 3-sphere invariant?

Remark 1.10. Note that the analogous statement of Question 1 for knot invariants is true, but harder than the previous statements about weight systems. Note also that a positive answer to Question 1 implies that \mathcal{O} is a commutative co-commutative Hopf algebra (with comultiplication defined by the connected sum of integral homology 3-sphere), and therefore a symmetric algebra in a graded set of generators.

[†] The question has recently being answered positively by T. T. Q. Le, see the Appendix.

Question 2. In the case of sl_2 , is λ_n defined in [11] finite type?

Question 3. Is it true that finite type invariants of integral homology 3-spheres separate them?

Remark 1.11. The above two questions may well be contradicting each other, as in the case of knot invariants.

Much remains to be done.

2. THREE-DIMENSIONAL TOPOLOGY

In this section we prove Theorem 2. Our proof exploits the fact that diffeomorphic integral homology 3-sphere can be represented in different ways as Dehn surgery on framed links in S^3 . Though we do not know of a complete set of moves that relate two surgery presentations (within the category of integral homology 3-spheres), we can still prove Theorem 2.

We will show that the map $\tilde{O}_m^*: \mathcal{G}_m \widetilde{\mathcal{CM}} \rightarrow \mathcal{G}_m \mathcal{M}$, after *deframing* factors through a map $\mathcal{G}_m \mathcal{BM} / \{AS, IHX, IS\} \rightarrow \mathcal{G}_m \mathcal{M}$.

We begin with the following remark on drawing figures.

Remark 2.1. In all figures, the parts of the graphs and links not shown are assumed identical. We call a figure *homogenous* if all graphs (or links) shown have the same number of components; otherwise we call it *inhomogenous*. Given a figure, the graphs or links drawn in it represent elements in the graded space $\mathcal{M} / \mathcal{F}_{n+1} \mathcal{M}$ under the map of eq. (6), where n is the maximum of the number of components of the links shown on the figure. Notice that in a homogenous figure of n -component graphs or links, it is obvious that each element is a well defined element of $\mathcal{M} / \mathcal{F}_{n+1} \mathcal{M}$ under the map of equation (6), whereas in a non-homogenous figure it needs to be shown. Some examples of homogenous figures are shown in Figs 3–10 below. Some examples of inhomogenous figures are Figs 11 and 20 shown below.

2.1. Removing the marking

We begin with the following lemma:

LEMMA 2.2. *If two Chinese manifold characters with m edges differ by their marking as shown in Fig. 3, then they have the same image in $\mathcal{G}_m \mathcal{M}$ under the map \tilde{O}_m^* .*

Proof. We denote by L_1, L_2 and L_3 the three components of a framed link which are images of three edges around the trivalent vertex through the map \tilde{O}_m^* . In the same argument in [11], we can regard L_3 as an element $[x_1, x_2]$ in the fundamental group of the complement of $L_1 \cup L_2$ which is generated by two meridians x_1 and x_2 . If we make a mark on the first (resp. second) edge near the trivalent vertex, the element becomes $[x_1^{-1}, x_2]$ (resp. $[x_1, x_2^{-1}]$). Since these two elements are conjugate in the fundamental group, they express the same element in $\mathcal{G}_m \mathcal{M}$ as in [11]. This implies the relation in Fig. 3. □

LEMMA 2.3. *We have a relation in $\mathcal{G}_* \widetilde{\mathcal{CM}}$ shown in Fig. 4.*

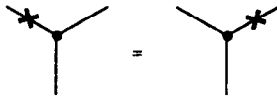

Fig. 3. Moving the marking on adjacent edges of a graph.

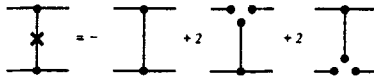

Fig. 4. Removing a marking of a graph.

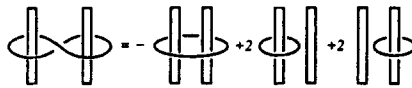

Fig. 5. Untying a half twist.

Proof. This relation is a direct conclusion of a relation in $\mathcal{G}_*\mathcal{M}$ shown in Fig. 5, which can be obtained in the same way as in [11]. It also follows from Theorem 5 of [6]. \square

2.2. A graphical representation of the deframing map $F: \widetilde{\mathcal{B}\mathcal{M}} \rightarrow \widetilde{\mathcal{B}\mathcal{M}}$

In order to give a cleaner form of Lemmas 2.2 and 2.3 (and also being motivated by Theorem 5 of [6]), we introduce white vertices, whose graphical definition is shown in Fig. 6. More precisely, we can give an alternative definition through the following deframing map.

Definition 2.4. The deframing map

$$F: \widetilde{\mathcal{C}\mathcal{M}} \rightarrow \widetilde{\mathcal{C}\mathcal{M}} \tag{11}$$

is defined as follows: for a manifold Chinese character Γ , let

$$F(\Gamma) = \sum_{c \subseteq v_3(\Gamma)} (-1)^{|c|} \Gamma^c \tag{12}$$

where the summation is over the set of all subsets of the set $v_3(\Gamma)$ of trivalent vertices of Γ , and Γ^c is the graph obtained by splitting each trivalent vertex in c with 3 univalent ones, as in Fig. 6. Here $|c|$ stands for the cardinality of the set c .

We now compose the map (6) with the deframing map (11) of Definition 2.4.

The deframing map F is a map between two copies of $\widetilde{\mathcal{C}\mathcal{M}}$. In order to distinguish these two copies, we use the following conventions; we draw an extended Chinese manifold character graph which belongs to the first $\widetilde{\mathcal{C}\mathcal{M}}$ (source of F) by a graph with white trivalent vertices (\circ), whereas an extended Chinese manifold character graph which belongs to the second $\widetilde{\mathcal{C}\mathcal{M}}$ (image of F) is drawn by a graph with black trivalent vertices (\bullet). By identifying these two copies of $\widetilde{\mathcal{C}\mathcal{M}}$ through F , we obtain the relation between \circ and \bullet vertices as shown in Fig. 6.

With respect to this substitution, Lemmas 2.2 and 2.3 become the following two lemmas.



Fig. 6. The definition of a \circ vertex.

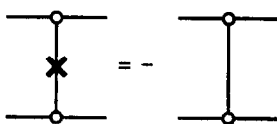

Fig. 7. An equivalent form of Lemma 2.3.



Fig. 8. Proof of Lemma 2.7.

LEMMA 2.5. *A mark can move beyond a white trivalent vertex.*

Proof. This lemma is immediately obtained from Lemma 2.2 by the definition of white vertex, noting that a mark near a univalent vertex can be removed. □

LEMMA 2.6. *The relation in Fig. 7 holds.*

Proof. This lemma is obtained from Lemma 2.3 by the definition of white vertex and the fact that a graph including a connected component with one edge and two univalent vertices is equivalent to zero. □

2.3. A vanishing lemma

LEMMA 2.7. *If a graph has a connected component containing a univalent vertex, no black vertices and at least two white vertices, then it is equal to zero in $\mathcal{G}_* \mathcal{M}$.*

Proof. This lemma follows from the calculation in Fig. 8 using Lemmas 2.5 and 2.6. □

We can now give a proof of Lemma 1.5 as follows:

Proof of Lemma 1.5. The space $\mathcal{G}_n \widetilde{\mathcal{M}}$ is spanned by graphs with white trivalent vertices and univalent vertices. Let Γ be a such graph.

If a graph Γ contains a univalent vertex, then it is equivalent to zero unless the univalent vertex belongs to a Y component. Hence we can assume every connected component of Γ is either a Y graph, or a trivalent graph with white vertices and no univalent vertices. Since the number of edges in any trivalent graph is divisible by 3, we obtain this lemma. □

2.4. Proof of the AS relation

PROPOSITION 2.8. *The relation in Fig. 9 holds, which is called AS (anti-symmetry) relation. Here we use “blackboard cyclic order”, i.e. we assume that each vertex has clockwise cyclic order when it is depicted in a plane.*

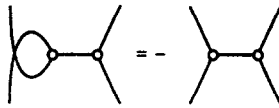

Fig. 9. The AS relation with an extra vertex.

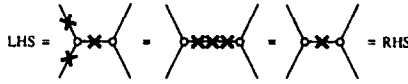

Fig. 10. Proof of Proposition 2.8.

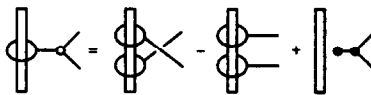

Fig. 11. Breaking a white vertex. The uni-trivalent graphs in the first and fourth (resp. second the third) parts of the figure have n (resp. $n - 1$) components. The figure represents an identity in $\mathcal{M}/\mathcal{F}_{n+1}\mathcal{M}$.

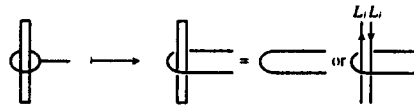

Fig. 12. The definition of a band.

Proof. We show a proof using Lemmas 2.5 and 2.6 in Fig. 10. □

Remark 2.9. Up to now, with the terminology of [6], we only used the relations of surgical equivalence and the fundamental relation of Theorem 4.1 of [11] (for a precise reformulation, see Theorem 5 of [6]) in order to show the AS relation of Fig. 9.

Remark 2.10. One word of caution though: in the 3-manifold graphs, the Y graph does not vanish, whereas in the Vassiliev invariants graphs, the Y graph vanishes. The reason is that the 3-manifold AS relation needs an external vertex, otherwise it is a *symmetry* relation. This was observed in [6] too, and seems to be responsible for the existence of the Casson invariant.

2.5. Proof of the IHX relation

In order to prove IHX relation, we begin with the following lemma.

LEMMA 2.11. *The relation in Fig. 11 holds, where by a band we mean either the empty set or two parallel strings with opposite orientations in a component of a framed link as shown in Fig. 12.*

Proof. Consider two framed n -component links shown in Fig. 13, whose framings are all $+ 1$. By ($\# 1$) and ($\# 2$) we mean elements in $\mathcal{G}_n\mathcal{M}$, where we express $(S^3, \mathcal{L}) \in \mathcal{G}_*\mathcal{M}$ by a picture of \mathcal{L} according to Remark 2.1.

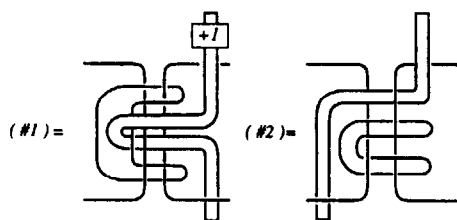

Fig. 13. The definition of (#1) and (#2).

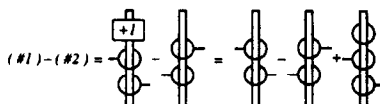

Fig. 14. The calculation of (#1) - (#2). An inhomogenous figure that represents an identity in $\mathcal{M}/\mathcal{F}_{n+1}\mathcal{M}$.

Let \mathcal{L} (resp. \mathcal{L}'_1) be the middle component of the framed link \mathcal{L} (resp. \mathcal{L}') which expresses (#1) (resp. (#2)). Note that we can obtain \mathcal{L} by taking handle slide of the band in \mathcal{L}' along \mathcal{L}'_1 , which means $(S^3_{\mathcal{L}'_1}, \mathcal{L} - \mathcal{L}_1) = (S^3_{\mathcal{L}'_1}, \mathcal{L}' - \mathcal{L}'_1)$. Since

$$(S^3, \mathcal{L}) = (S^3, \mathcal{L} - \mathcal{L}_1) - (S^3_{\mathcal{L}'_1}, \mathcal{L} - \mathcal{L}_1)$$

$$(S^3, \mathcal{L}') = (S^3, \mathcal{L}' - \mathcal{L}'_1) - (S^3_{\mathcal{L}'_1}, \mathcal{L}' - \mathcal{L}'_1)$$

we can calculate (#1) - (#2) by eliminating the middle components as in Fig. 14.

On the other hand we can deform (#1) and (#2) into graphs, respectively. We show a calculation for (#1) in Fig. 15 where we use Lemma 2.12 below to obtain the last term. In a similar way we can obtain the corresponding graph to (#2) as shown in Fig. 16.

Combining the results of Figs 14–16 we obtain the required formula. □

LEMMA 2.12. *The relation in Fig. 17 holds.*

Proof. Since we can change an order of two winding parts in a framed link of n components in $\mathcal{G}_n\mathcal{M}$, we obtain the formula in Fig. 18.

Using Lemma 3.4 in [6] and the above formula, we have the calculation in Fig. 19, which shows the required formula. □

LEMMA 2.13. *The relation in Fig. 20 holds.*

Proof. The idea of the proof is to apply Lemma 2.11 twice. Since the identity of Lemma 2.11 is inhomogenous and involves n and $n - 1$ component links, whereas the identity of Fig. 20 is inhomogenous, and involves n and $n - 2$ component links, it is not a priori clear that we can apply Lemma 2.11 twice. Instead, we will apply the *proof* of Lemma 2.11 twice.

Now, for the proof, consider “ c ” and “ v ” defined as in Fig. 21. We apply the same argument as the proof of Lemma 2.11 to the left white vertex in the left-hand side of the required formula, expressing the right vertex with “ c ” or “ v ”, as follows.

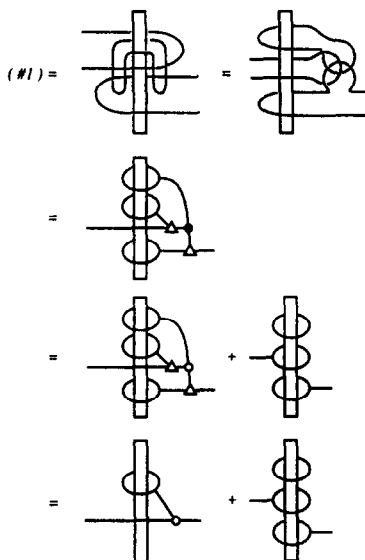

Fig. 15. The calculation of (#1).

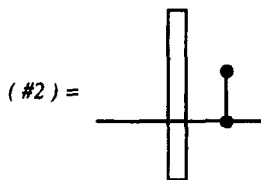

Fig. 16. The calculation of (#2).

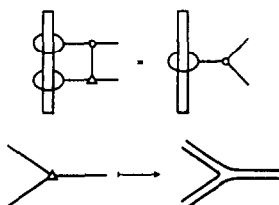

Fig. 17. The definition of a triangle (shown on the lower part of the figure) and an identity in \mathcal{G}_n among white and triangle vertices of n -component links (shown on the upper part of the figure).

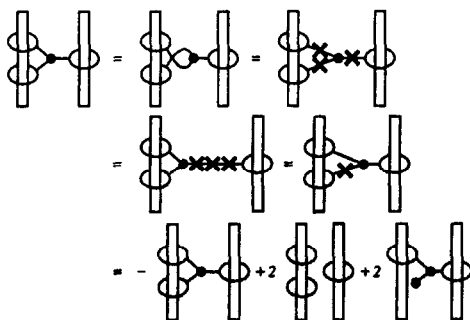

Fig. 18. A vertex between two bands.

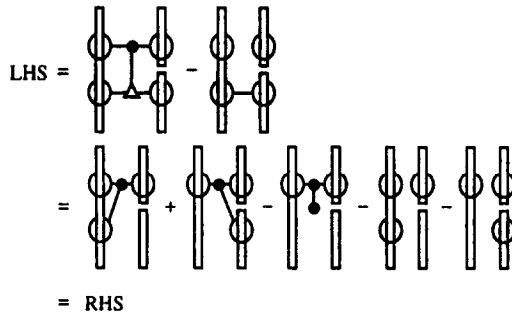

Fig. 19. Proof of Lemma 2.12.

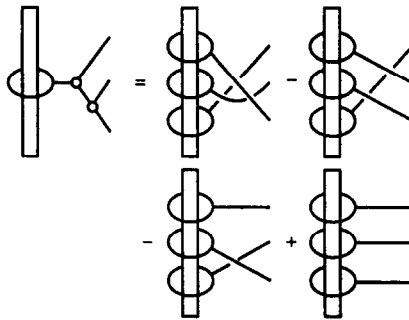

Fig. 20. Breaking two white vertices. An inhomogenous figure that represents an identity in $\mathcal{M}/\mathcal{F}_{n+1}\mathcal{M}$. The link on the left has n components, and the four links on the right have $n - 2$ components.

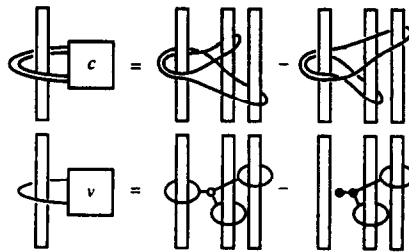

Fig. 21. The definition of c and v .

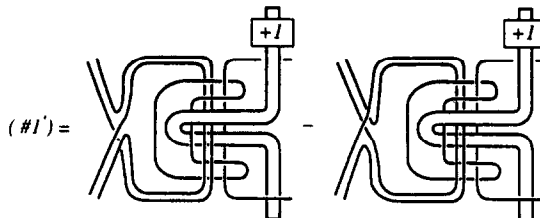

Fig. 22. The definition of $(\#1')$.

Instead of $(\#1)$ in Fig. 13, we put $(\#1')$ as in Fig. 22. We also put $(\#2')$ modifying $(\#2)$ similarly. Both $(\#1')$ and $(\#2')$ are n -component links. In the same way as the former part of the proof of Lemma 2.11, we obtain $(\#1') - (\#2')$ as in Fig. 23, noting that, in the former part, we used, not Lemma 2.12, but the handle slide move and calculations of alternating sum. Note also that we can replace c with v in the last picture in Fig. 23.

$$(\#1') - (\#2') = \boxed{c} \left[\text{Diagram 1} \right] - \boxed{c} \left[\text{Diagram 2} \right] + \boxed{c} \left[\text{Diagram 3} \right]$$

Fig. 23. The calculation of $(\#1') - (\#2')$ in $\mathcal{M}/\mathcal{F}_{n+1}\mathcal{M}$. An inhomogenous figure where the last three links have $n - 1, n - 1$ and n components, respectively.

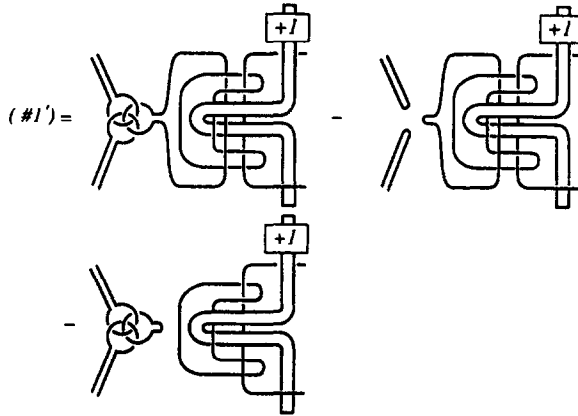

Fig. 24. Another form of $(\#1')$. A homogenous figure.

$$(\#1') = \boxed{v} \left[\text{Diagram 1} \right] + \boxed{v} \left[\text{Diagram 2} \right]$$

Fig. 25. The calculation of $(\#1')$.

$$\text{Diagram 1} = \text{Diagram 2} - \text{Diagram 3}$$

Fig. 26. The *IHX* relation.

$$\text{Diagram 1} + \text{Diagram 2} + \text{Diagram 3} = 0$$

Fig. 27. Proof of the *IHX* relation.

On the other hand we can deform $(\#1')$ as in Fig. 24 by Lemma 2.11. Further we obtain the formula in Fig. 25 in the same way as the latter part of the proof of Lemma 2.11. The same argument is valid for $(\#2')$. Repeating the above argument once again we obtain the required formula in the same way as the proof of Lemma 2.11. \square

PROPOSITION 2.14. *The relation in Fig. 26 holds, which is called the IHX relation.*

Proof. Sum up three formulas obtained by taking cyclic permutation of both sides of the formula in Fig. 20. Then we find that the right hand side vanish. Hence we have the formula in Fig. 27, which becomes the *IHX* relation using the *AS* relation. \square

Proof (end of the proof of Theorem 2). The first part of Theorem 2 was shown above.

For the second part, we have the fact that \tilde{O}_m^* is onto by Theorem 1 of [11], and that the deframing map F is an isomorphism by its definition. Hence it is sufficient to show that for any ECMC Γ with univalent and white trivalent vertices there exists a CMC which has the same image in $\mathcal{G}_m\mathcal{M}$. As in the proof of Lemma 1.5 in Section 2.3, we can show that every connected component of Γ is either a *Y* component or a trivalent graph with white vertices. Further we can show that the image of a Θ component[†] with white vertices in $\mathcal{G}_m\mathcal{O}$ is equal to two times the image of a *Y* component by using arguments in [11]; note that we have the fact that $\mathcal{G}_3\mathcal{M}$ is one dimensional in [11]. Therefore we can replace a *Y* component with half times a Θ component with white vertices, completing this part.

For the third part, use the fact that O_m^* is onto and the definition of $\mathcal{G}_m\mathcal{O}$. The proof of Theorem 2 is complete. \square

3. COMBINATORICS OF MANIFOLD WEIGHT SYSTEMS

In this section we concentrate on the combinatorics of manifold weight systems. Our arguments are combinatorial, with little resemblance to low dimensional topology.

We begin with the following definition:

Definition 3.1.

- Let $\mathcal{C}\mathcal{M} \otimes \mathcal{C}\mathcal{M} \rightarrow \mathcal{C}\mathcal{M}$ be defined by the disjoint union of Chinese manifold characters.
- Let $\Delta: \mathcal{C}\mathcal{M} \otimes \mathcal{C}\mathcal{M} \rightarrow \mathcal{C}\mathcal{M}$ be defined as follows: for a Chinese manifold character Γ , let

$$\Delta(\Gamma) = \sum_{\Gamma = \Gamma_1 \cup \Gamma_2} \Gamma_1 \otimes \Gamma_2 \tag{13}$$

where the summation is over all ways of splitting Γ as a disjoint union $\Gamma_1 \cup \Gamma_2$, where Γ_1, Γ_2 are *connected* Chinese manifold characters.

Proof (of Proposition 1.8). We claim that the above defined multiplication and comultiplication in $\mathcal{C}\mathcal{M}$ descends to a well defined one in $\mathcal{B}\mathcal{M}$, and that $\mathcal{B}\mathcal{M}$ becomes a commutative, co-commutative Hopf algebra. Indeed, it follows by definition that

$$\Delta(AS) = AS \otimes 1 + 1 \otimes AS$$

$$\Delta(IHX) = IHX \otimes 1 + 1 \otimes IHX$$

from which follows that the multiplication and the comultiplication descend in $\mathcal{B}\mathcal{M}$. Commutativity and co-commutativity are obvious, and so are verifying the rest axioms of the Hopf algebra. It is an easy exercise to show that the primitive elements in $\mathcal{B}\mathcal{M}$ are the *connected* Chinese manifold characters. Furthermore, it follows by definition that O_m is an algebra map. The proof of Proposition 1.8 is complete. \square

Recalling that the map $\iota: \mathcal{B}\mathcal{M} \rightarrow \widetilde{\mathcal{B}\mathcal{M}}$ of Definition 1.4 is an isomorphism, it follows that $\widetilde{\mathcal{B}\mathcal{M}}$ is also a commutative, co-commutative Hopf algebra, with multiplication $\tilde{\cdot}$, and comultiplication $\tilde{\Delta}$. We can now propose the following exercise:

[†] A Θ component is a trivalent graph with 2 vertices and 3 edges, as in the Greek letter Θ .

Exercise 3.2. Show that:

- $\tilde{\tau}: \widetilde{\mathcal{B}\mathcal{M}} \otimes \widetilde{\mathcal{B}\mathcal{M}} \rightarrow \widetilde{\mathcal{B}\mathcal{M}}$ is given by the disjoint union of extended Chinese manifold characters.
- $\tilde{\Delta}: \widetilde{\mathcal{B}\mathcal{M}} \otimes \widetilde{\mathcal{B}\mathcal{M}} \rightarrow \widetilde{\mathcal{B}\mathcal{M}}$ is given as follows: for an Chinese manifold character Γ , let

$$\tilde{\Delta}(\Gamma) = \sum_{c \in \{l,r\}^{e(\Gamma)}} \Gamma_l \otimes \Gamma_r \quad (14)$$

where the summation is over the set of all colorings of the edges $e(\Gamma)$ by l, r , and $\tilde{\Gamma}_l$ (resp. $\tilde{\Gamma}_r$) are the graphs obtained by choosing only the l -colored, (resp. r -colored) edges of Γ . The graphs $\tilde{\Gamma}_l$ and $\tilde{\Gamma}_r$ have vertices of valency 1, 2 and 3. After splitting every vertex of valency 2 in two vertices of valency 1, the resulting graphs Γ_l, Γ_r are Chinese manifold characters.

APPENDIX A. ADDENDUM

After completing the text of this paper, Le [8] proved the following theorem, based on our construction of the map O_m^* .

THEOREM 3. *The topological invariant $\Omega(M)$ of a 3-manifold M defined in [9] is the universal finite type invariant for integral homology 3-spheres and induces the inverse of the map (8) given in Theorem 2.*

COROLLARY A1. *The map O_m^* of (8) is an isomorphism of finite dimensional vector spaces.*

Dually we have,

COROLLARY A2. *Extending (9), we obtain the following short exact sequence:*

$$0 \rightarrow \mathcal{F}_{m-1} \mathcal{C} \rightarrow \mathcal{F}_m \mathcal{C} \rightarrow \mathcal{G}_m \mathcal{W}\mathcal{M} \rightarrow 0 \quad (\text{A1})$$

We note that in both cases of finite type invariants of knots and integral homology 3-spheres, the existence of the *universal* finite type invariant (due to Kontsevich [1] for knots, and Le [8] for integral homology 3-spheres) implies the isomorphism of Corollary A1 and the short exact sequence of Corollary A2.

Acknowledgements—The authors wish to thank the Mathematical Institute at Aarhus for the warm hospitality during which the last part of the paper was written. In particular, they wish to thank J. Andersen for organizing an excellent conference on finite type 3-manifold invariants, and for bringing together participants from all over the world. Especially they wish to thank P. Melvin and the anonymous referee for pointing out to us an insufficient explanation in the proof of Lemma 2.13 and the Internet for supporting numerous electronic communications.

The first author was partially supported by NSF grant DMS-95-05105. This and related preprints can also be obtained by accessing the WEB in the address <http://www.math.brown.edu/~stavros/>.

REFERENCES

1. S. Axelrod and I. M. Singer: Chern–Simons perturbation theory, *Proc. XXth DGM Conf.*, New York, 1991, World Scientific, Singapore (1992) pp. 3–45.
2. S. Axelrod and I. M. Singer: Perturbative aspects of Chern–Simons topological quantum field theory II, *J. Differential Geom.* **39** (1994), 173–213.
3. D. Bar-Natan: On the Vassiliev knot invariants, *Topology* **34** (1995), 423–472.

4. D. Bar-Natan: Computer data files available via anonymous file transfer from math.harvard.edu, user name `ftp`, subdirectory `dror`. Read the file `README` first.
5. S. Garoufalidis: On finite type 3-manifold invariants I, M.I.T. preprint (1995), *J. Knot Theory and its Ramifications*, **5** (1996), 441–462.
6. S. Garoufalidis and J. Levine: On finite type 3-manifold invariants II, *Math. Annalen* **306** (1996), 691–718.
7. M. Kontsevich: Vassiliev's knot invariants, *Adv. Sov. Math.* **16**(2) (1993), 137–150.
8. T. T. Q. Le: An invariant of integral homology 3-spheres which is universal for all finite type invariants, Soliton geometry and topology: on the crossroad, AMS translations **2**, Eds. S. Novikov.
9. T. T. Q. Le, J. Murakami and T. Ohtsuki: On a universal quantum invariant of 3-manifolds, to appear in *Topology*.
10. T. Ohtsuki: A polynomial invariant of integral homology spheres, *Math. Proc. Cambridge Philos. Soc.* **117** (1995), 83–112.
11. T. Ohtsuki: Finite type invariants of integral homology 3-spheres, preprint (1994), *J. Knot Theory and its Ramifications*, **5** (1996), 101–115.
12. L. Rozansky: The trivial connection contribution to Witten's invariant and finite type invariants of rational homology spheres, preprint `q-alg/9503011`.
13. L. Rozansky: Witten's invariants of rational homology spheres at prime values of K and the trivial connection contribution, *Commun. Math. Phys.* **180** (1996), 297–324.
14. M. E. Sweedler: Hopf Algebras, Benjamin, New York (1969).
15. V. A. Vassiliev: Complements of discriminants of smooth maps, *Transl. Math. Monographs* **98**, Amer. Math. Soc., Providence, RI (1992).
16. E. Witten: Quantum field theory and the Jones polynomial, *Commun. Math. Phys.* **121** (1989), 360–376.

Department of Mathematics
Massachusetts Institute of Technology
Cambridge, MA 02139
U.S.A.

Department of Mathematical and Computing Sciences
Tokyo Institute of Technology
Oh-okayama, Meguro-ku
Tokyo 152
Japan